

OtterPro



+86-191 2822 1262



info@otterdtf.com



www.otterdtf.com



VERSION: 202408

OtterPro

OTTER DTF SYSTEM

Print, Cure, Wow
with Otter DTF System!

DTF Printer / Shaker / Film / Ink
Powder / Oven Dryer / Purifier
Heat Press / DTF Printables

UV DTF Printer / UV DTF Consumables

www.otterdtf.com



OtterPro

Elevate your business with OtterPro's advanced DTF printing system solutions, including DTF printers, UV DTF printers, and many other DTF printer series. Our tailor-made "Start to Finish" approach empowers makers, retailers, and manufacturers to enhance efficiency and innovation.

With cutting-edge technology, exceptional quality, and a focus on environmental sustainability, we're committed to boosting your productivity and competitiveness. Partner with OtterPro and transform your business into a beacon of success and efficiency.



Local Services

To ensure prompt and seamless support for OtterPro DTF printer users worldwide, we've established multiple OtterPro DTF Printer local service stations across the United States, Mexico, Panama, and Europe. Our comprehensive one-stop service center covers everything from purchasing and installing DTF printers to after-sales support, training, maintenance, repairs, and more. And we're still working on establishing OtterPro DTF service stations globally.

Besides the local service stations, you can also find OtterPro DTF products in Canada, Thailand, Saudi Arabia, Dubai, and other South American countries. If you need further assistance, please feel free to contact us!

Textile DTF

Printing Solution for Soft Fabrics

OtterPro DTF printer performs amazingly well on almost all kinds of fabrics, including t-shirts, safety vests, hats, masks, shoes, banners, towels, aprons, bags, slippers, PU notebooks, coasters and more.



T-shirt



Hoodie



Apron



Hat



Pillowcase



Canvas bag



Shoes



Mouse pad

UV DTF

Printing Solution for Hard Substrates

Otter Pro UV DTF Printer produces permanent stickers that can be applied on almost hard, smooth, and even curved, cylindrical objects.



Mug/Tumbler Wrap



Phone Case



Laptop



Photo Frame



Closet Label



Gift Wrapping



Packaging Bag



Retail Packaging



DTF PRINTING

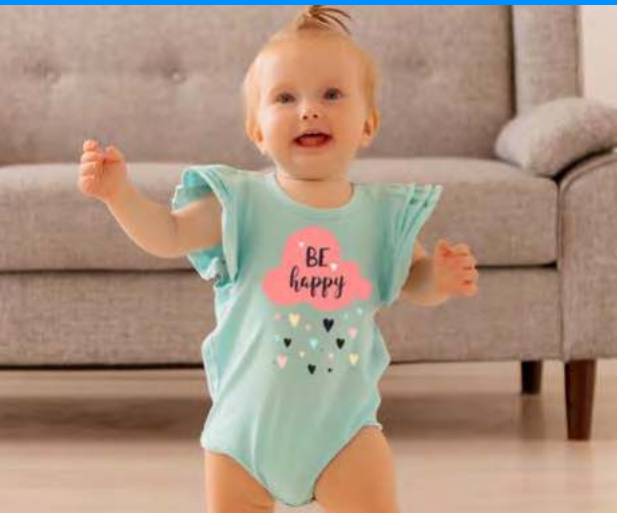



Mass Production Solution

Experience boundless printing options with our all-in-one DTF system—ideal for large-scale production or small-volume printing. Perfect for retailers or home makers, it integrates printing, powder shaking, heating, and purifying functions, providing efficiency and quality in a compact design. Fully automated features enhance workflow, ensuring high productivity and top-notch output. Our specialized vertical heat press ensures optimal efficiency, delivering your best prints in minutes.



01 Use the DTF system to print, shake and dry your design

02 Transfer design with OtterPro clamshell heat press

Model M 30 OtterPro DTF Printer System

Model C 30 is a compact, desktop DTF printer perfect for home use and workshop. The maximum print size is 30 cm/11.8in, ideal for most small business needs. It's equipped with an Epson F1080 printhead for stable and precise prints. Plus, it also comes with a handy cutter that makes film cutting easier.



Epson XP600(F1080) 1 PCS

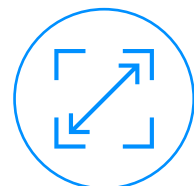

Print Width
0-300mm/11.8in Max



Detachable Film Trimmer



Convenient

Simple operation
Stable performance
Easy to maintain
One-stop consumables



Safe & Intelligent

Automatic cleaning system
White ink alarm system
Peristaltic pump



High Efficiency

Front stage heating
Adjustable suction system
Multi-language RIP software

Model No.	MODEL M30LB	Print Accuracy	1440dpi
Printhead	Epson XP600(F1080) x1	Print Speed	720*900dpi (4pass) Print Speed: 4m ² /H 720*1080dpi (6pass) Print Speed: 2m ² /H 720*1400dpi (8pass) Print Speed: 1.2m ² /H
Voltage	110V/220V±10% 50Hz-60Hz	Print Mode	Uni-direction / Bi-direction
Power	300W 5A-10A	Operating Environment	Temperature: 15-30°C Humidity: 35-65% (no condensation)
Language Options (Control Panel)	Chinese/English	Ink Stirring System	Semi-automatic white ink stirring
Printer Software	Model M 30 DTF	Adsorption Platform	Adjustable suction platform
Design Software	OtterPro RIP	Heating System	Front stage heating
Language Options (Software)	Chinese/English/French/German/Italian/Polish/Portuguese/Spanish	Connection Method	3.0 USB cable
Ink Type	Eco Textile Pigment Ink	System Requirements	Window 7 or above (macOS system is not supported)
Ink Color	H1: K+C+M+Y+W	Supported Formats	PRT, PRN, BMP, JPG, PNG, TIFF, EPS, PDF
Print Thickness	0-3 mm (75-90u)	Printer Specification	78.5 x 70.5 x 39.5 cm / 30.9 x 17.7 x 15.5 in / 37kg
Print Width	0-300 mm / 0-11.8in	Package Dimension	103.5 x 48 x 54.5 cm / 40.7 x 18.8 x 21.4 in / 50 kg

ACCESSORIES:
Ink Damper X3, Cap Top X1, Ink Pump x1, Ribbon Cable X2, Sensor Limit Switch x1, Ink Tube X1, Peristaltic Pump X1, Syringe X1, Bubble Level x1, Hex Key Set X1, Phillips Screwdriver X1, M4 Screw Set X1, Encoder Strip X1, Glove X2, Wiper Blade X1

NOTE:
The DTF printer is covered by a 2-year limited warranty. Additionally, parts that come in contact with ink, including ink cartridges, printheads, wiper blades, and other consumable parts, are also covered under warranty with an extra cost.

Model S 40 All-in-One Otter DTF System

Model S 40 is an All-in-One DTF printer that combines printing, powder shaking, curing, and purifying in one machine. With a maximum print width of 44.8cm/17.6in, it's compatible with the standard film widths in the market, including 30cm, 33cm, 42cm and more size.



Epson i1600 2 PCS

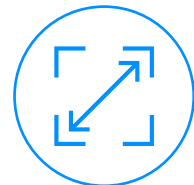

Print Width

0-448mm/17.6in Max



NOTE: DTF printer can be sold separately.

Model No.	OT-AIODTF40LB	Nozzle Resolution	300ppi 600ppi
Printhead	Epson i1600 x2	Print Speed	720*1200dpi (4pass) Print Speed: 3.5-5.0m ² /H 720*1800dpi (6pass) Print Speed: 2.5-3.5m ² /H 720*2400dpi (8pass) Print Speed: 2.0-3.0m ² /H
Voltage	220V ±10% 50Hz	Print Mode	Uni-direction / Bi-direction
Power	2500W MAX±5%	Operating Environment	Temperature: 15-30°C Humidity: 35-65% (no condensation)
Language Options (Control Panel)	Chinese/English	Ink Stirring System	White ink automatic stirring circulation
Printer Software	Model S 40 DTF	Adsorption Platform	Adjustable suction platform
Design Software	OtterPro RIP	Heating System	Three Stages Independent Heating
Language Options (Software)	Chinese/English/French/German/Italian/Polish/Portuguese/Spanish	Connection Method	Gigabit Ethernet Port (PC must have Gigabit Ethernet Card)
Ink Type	Eco textile pigment ink	System Requirements	Window 7 or above (macOS system is not supported)
Ink Color	H1: K+C+M+Y H2: W+W+W+W	Supported Formats	PRT, PRN, BMP, JPG, PNG, TIFF, EPS, PDF
Print Thickness	0-3 mm (75-90u)	Product Dimensions	220 x 100 x150 cm / 86.6 x 39.3 x 59 in
Print Width	0-448 mm / 0-17.6 in	Weight	380kg
ACCESSORIES: Cap Top x2, Ink Tube x4, Ribbon Cable x2, Ink Damper x2, Network Cable x1, 20ml Syringe x1, M3 Screw x12, M4 Screw x 6, Power Cord x1, Hex Key Set x1, Phillips Screwdriver x1		Powder Capacity	1.5kg

NOTE:
The DTF printer is covered by a 2-year limited warranty. Additionally, parts that come in contact with ink, including ink cartridges, printheads, wiper blades, and other consumable parts, are also covered under warranty with an extra cost.

Model S 60 All-in-One Otter DTF System

The maximum print size of this large format all-in-one DTF printer is 60cm/23.6in, equipped with two advanced Epson i3200 printheads, this printer delivers faster and more precise prints. It's perfect for printing on larger garments, jeans, trade show banners, posters, and allowing mass production of custom clothing and more largescale projects.



Note: The printer and shaker are sold as a set.

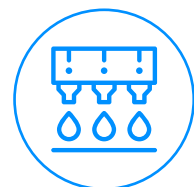

Epson i3200 2 PCS

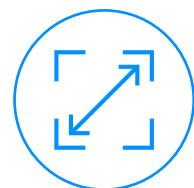

Print Width
0-600mm/23.6in Max

Model No.	OT-AIODTF60LB	Nozzle Resolution	360ppi 480ppi
Printhead	Epson i3200 x2	Print Speed	720*1200dpi (4pass) Print Speed: 14m ² /H 720*1800dpi (6pass) Print Speed: 10m ² /H 720*2400dpi (8pass) Print Speed: 6m ² /H
Voltage	110V/220V±10% 50Hz-60Hz	Print Mode	Uni-direction / Bi-direction
Power	3300W MAX±5%	Operating Environment	Temperature: 15-30°C Humidity: 35-65% (no condensation)
Language Options (Control Panel)	Chinese/English	Ink Stirring System	White ink automatic stirring circulation
Printer Software	Model S 60 DTF	Adsorption Platform	Adjustable suction platform
Design Software	OtterPro RIP	Heating System	Three stages independent heating
Language Options (Software)	Chinese/English/French/German/Italian/Polish/Portuguese/Spanish	Connection Method	Gigabit ethernet port (PC must have gigabit ethernet card)
Ink Type	Eco textile pigment ink	System Requirements	Window 7 or above (macOS system is not supported)
Ink Color	H1: K+C+M+Y H2: W+W+W+W	Supported Formats	PRT, PRN, BMP, JPG, PNG, TIFF, EPS, PDF
Print Thickness	0-3 mm (75-90u)	Product Dimensions	236 x 156.5 x 141.5 cm / 92.9 x 61.6 x 55.7 in
Print Width	0-600 mm / 0-23.6 in	Weight	581kg
ACCESSORIES: Cap Top x2, Ink Tube x4, Ribbon Cable x2, Ink Damper x2, Network Cable x1, 20ml Syringe x1, M3 Screw x12, M4 Screw x 6, Power Cord x1, Hex Key Set x1, Phillips Screwdriver x1		Powder Capacity	1.5kg
NOTE: The DTF printer is covered by a 2-year limited warranty. Additionally, parts that come in contact with ink, including ink cartridges, printheads, wiper blades, and other consumable parts, are also covered under warranty with an extra cost.			

Advantages of Model S Series Printers



Stable & Quiet

DC motor controller
Double silent circular guide rails
Steel body



Safe & Intelligent

White ink automatic circulation stirring system
Automatic cleaning system
Alarm system
Peristaltic pump



High Efficiency

Three heating stages
Adjustable suction system
Multi-language RIP software

Auto White Ink Circulation System Auto Cleaning System

Consistent Print Quality. Increased Efficiency. Cost Savings.
Peristaltic pump with moderate pressure and great gas sealing to protect the printer head.

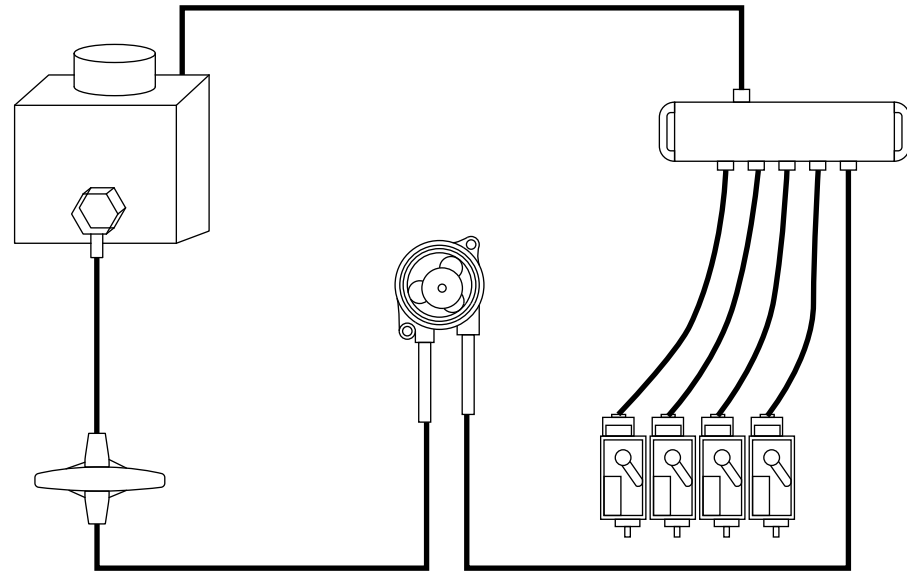

Ink Supply System

Clear ink markings save the hassle of pouring the wrong ink. The built-in alarm sensor reminds you to add ink in time, minimizing damage to the printer.

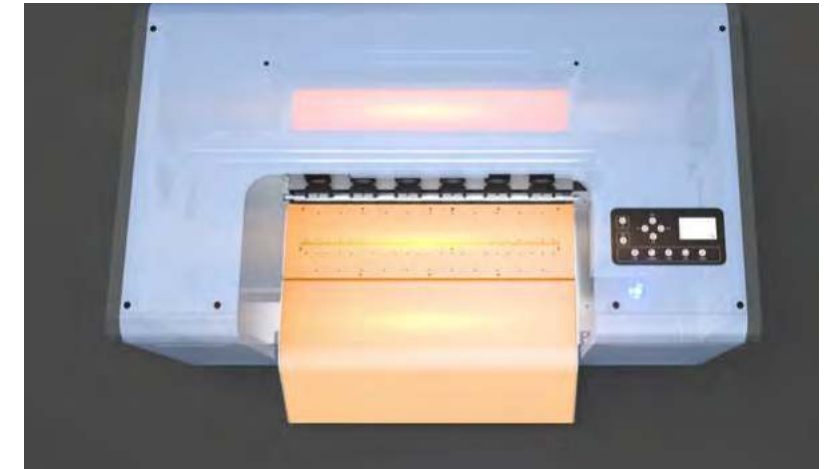

Three-stage Heating System

Accelerate DTF Ink drying speed on the film to guarantee optimal image quality before applying powder.

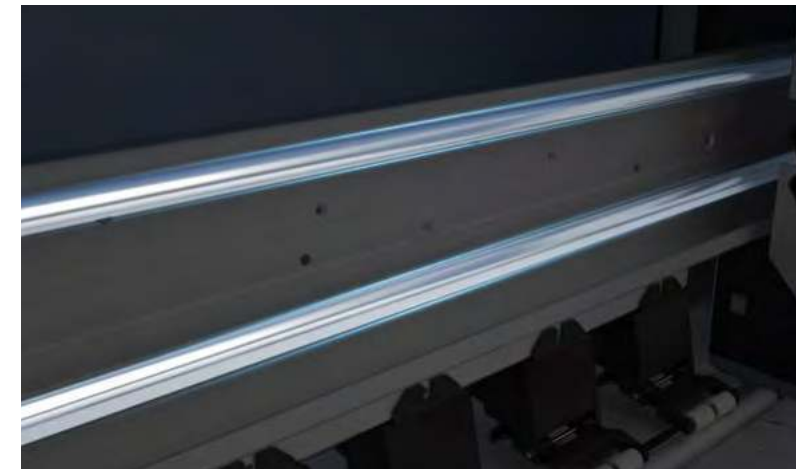

Double Silent Circular Guide Rails

Enhance operational stability with minimal noise.

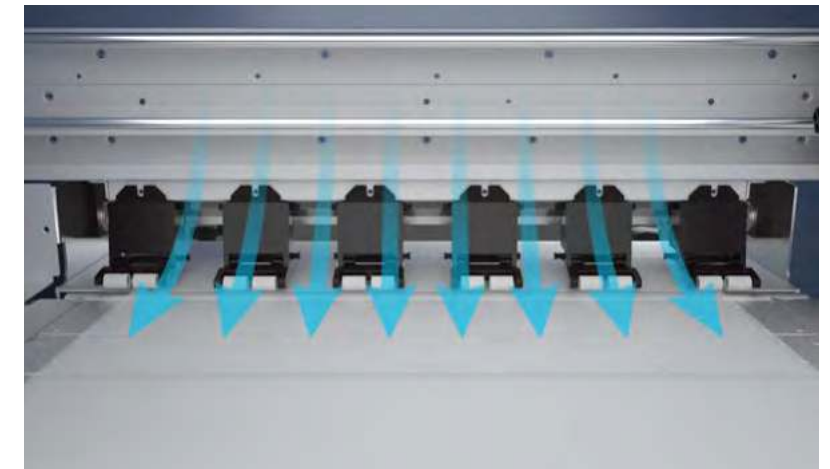

Adjustable Vacuum Suction Platform

Deliver precise color printing with no deviations, ensuring a flat and seamless film output.

Powder Shaking System

Printing, Shaking & Curing Integrated

Suitable for High & Low-volume Production

Simple & Easy to Operate



Otter All-in-One DTF System Go-to Choice for Efficient Batch Printing

An Otter all-in-one DTF system can print 1575 logos of 5.5*5.5 cm, and 7 clamshell heat presses can print about 1575-3000 t-shirts

JUST ONE HOUR!



Otter All in One DTF System



Clamshell Heat Presses



Printed T-shirts

All-in-One Automated DTF System

Equipped with sensors, the automated system enables one-touch controls for automatic printing, powder shaking, drying, and film winding.

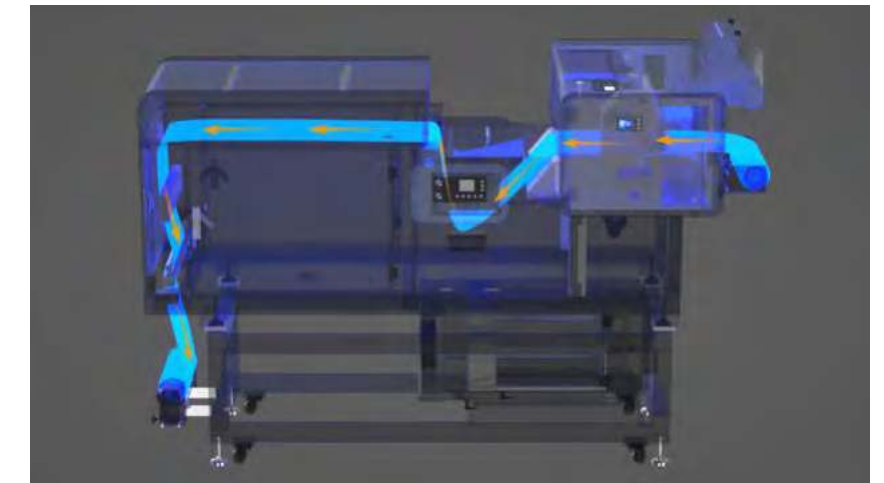



Control Panel

Manage the speed, power and temperature of the powder shaking and drying system with this intuitive control panel.

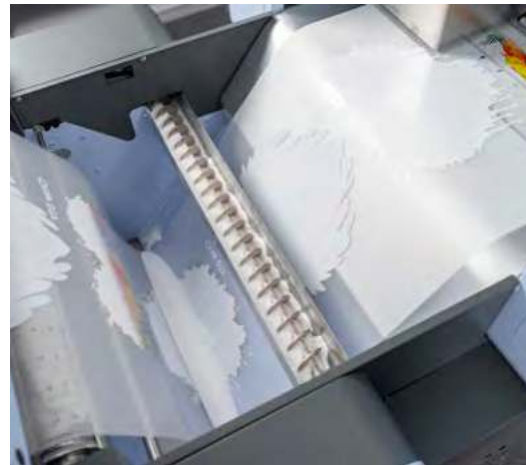

Auto Powder Recycling System

It can effectively improve the utilization rate of hot melt powder and minimize waste. In addition, it saves the hassle of shaking powder by hand, allowing the powder to be spread more evenly on the film.

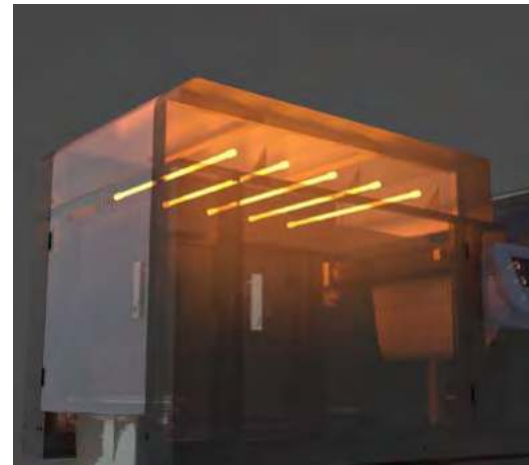

Drying System

Equipped with five heating tubes and a larger drying area, our drying system ensures more uniform heating for your project, delivering superior outcomes.



Auto Take-up Reel System

With the automatic take-up reel system, you can free up your hands in the final production stage, achieving intelligent and secure film winding.



Built-in Fans

After the printed film is baked in the oven, the built-in fans accelerate film cooling and improve work efficiency.

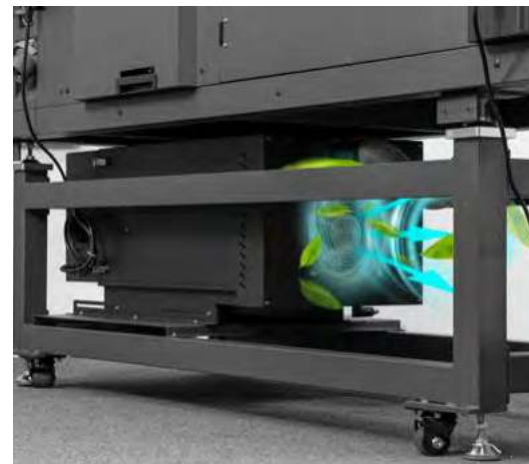

Integrated Purifier

The air and oil purifier system can automatically treat smoke and oil and promote well-being and productivity. (No need to replace the filter cotton)

Tri-layer A3 DTF Dryer Pro & Air Purifier

Item No.	OT-DRYA3LB (Dryer)	OT-FLLB (Purifier)	Voltage	220V / 110V 50~60Hz
Power	1450W MAX±5%	150W MAX±5%	Temp. Range	104-302 °F (40-150°C)
Size	544*603*303mm	365*325*525mm	Time Range	1-60min
Weight	14.5 kg	9.5 kg	Film Size	300 x 420mm / 11.8 x 16.5 in



OtterPro portable purifier provides you a fresh air throughout your workspace. Easy to carry, simple to use. Experience an atmosphere that promotes well-being and productivity with our efficient air purification system.



High Efficiency

The three-layer design dries 3 sheets of A3 or 6 sheets of A4 film at a time, making it an efficient choice for DTF projects.



Even Heating

The desktop DTF dryer features a hot air circulation design that ensures even heating and melting powder, delivering crisper, more durable and vibrant prints.

Better Results: The upgraded heating tunnel prevents oiling with a better curing effect

Max. temperature up to 150°C



**UV DTF
PRINTING**



Model C 30 OtterPro UV DTF Printer

Model C 30 is a UV DTF printer that combines printing and lamination in one machine. No heat press is required, apply your stickers onto wood, metal, plastic, glass, acrylic, paper and almost any smooth, hard, cylindrical objects with ease!



Epson i3200-U1 HD 1 PCS

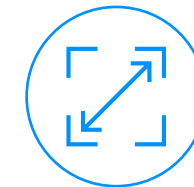

Print Width
0-300mm/11.8in Max



Convenient
Simple operation
Stable performance
Easy to maintain
One-stop consumables



Safe & Intelligent
White ink automatic circulation system
Automatic cleaning system
Alarm system
Peristaltic pump



High Efficiency
Adjustable heating rollers
Built-in suction system
Multi-language RIP software

Model No.	MODEL C30LB	Nozzle Resolution	300ppi 600ppi
Printhead	Epson i3200-U1 HD x1 (8 Colors)	Print Speed	960*900dpi (6pass) Print Speed: 3.5-5.0m ² /H 960*1200dpi (8pass) Print Speed: 2.5-3.5m ² /H
Voltage	110V/220V±10% 50Hz-60Hz	Print Mode	Uni-direction / Bi-direction
Power	410W 5A-10A	Operating Environment	Temperature: 15-30°C Humidity: 35-65% (no condensation)
Language Options (Control Panel)	Chinese/English	Ink Stirring System	White ink automatic circulation
Printer Software	Model C 30 UV DTF	Printhead Maintenance	Fully automatic cleaning, ink scraping, moisturizing
Design Software	OtterPro RIP	Heating System	Adjustable heating rollers
Language Options (Software)	Chinese/English/French/German/Italian/ Polish/Portuguese/Spanish	Connection Method	Gigabit Ethernet Port (PC must have Gigabit Ethernet Card)
Ink Type	UV Ink	System Requirements	Window 7 or above (macOS system is not supported)
Ink Color	K+C+M+Y+W1+W2+V1+V2	Supported Formats	PRT, PRN, BMP, JPG, PNG, TIFF, EPS, PDF
Printing Method	A complete white ink, color, varnish hierarchical order printing	Printer Specification	96 x 98 x 45 cm / 37.7 x 38.5 x 17.7 in / 75kg
Print Width	0-300 mm / 0-11.8 in	Package Dimension	112 x 112 x 63 cm / 44 x 44 x 24.8 in / 95kg

NOTE:

The UV DTF printer is covered by a 2-year limited warranty. Additionally, parts that come in contact with ink, including ink cartridges, printheads, wiper blades, and other consumable parts, are also covered under warranty with an extra cost.



Epson i3200-U1 HD Printhead

The unique printhead design features 8 channels for 4 colored inks, 2 white inks, and 2 varnishes, delivering vibrant colors with faster and more accurate alignment.

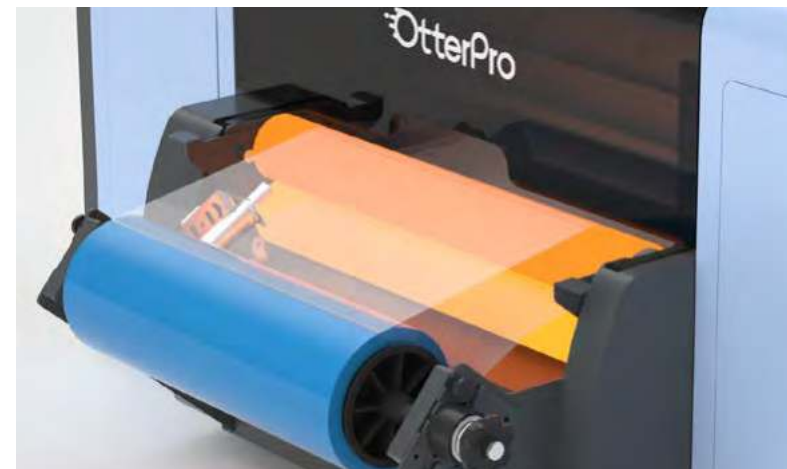

Adjustable Heating Rollers

Ensuring precise and uniform heat distribution to achieve a bubble-free laminating effect.



Compact & Desktop

Compact desktop design, no extra stand required, ideal for small batch production at home or workshop.

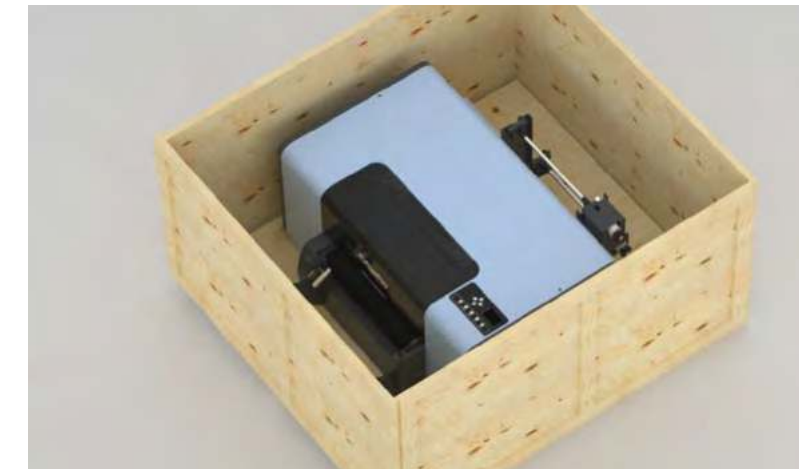

Integrated Printing & Lamination

Model C 30 integrates printing, curing, and laminating in a single process. No heat press and cutter required to create permanent stickers for your projects. (Extra protection for integrity and safe transport)

OtterPro Multi-language RIP Software

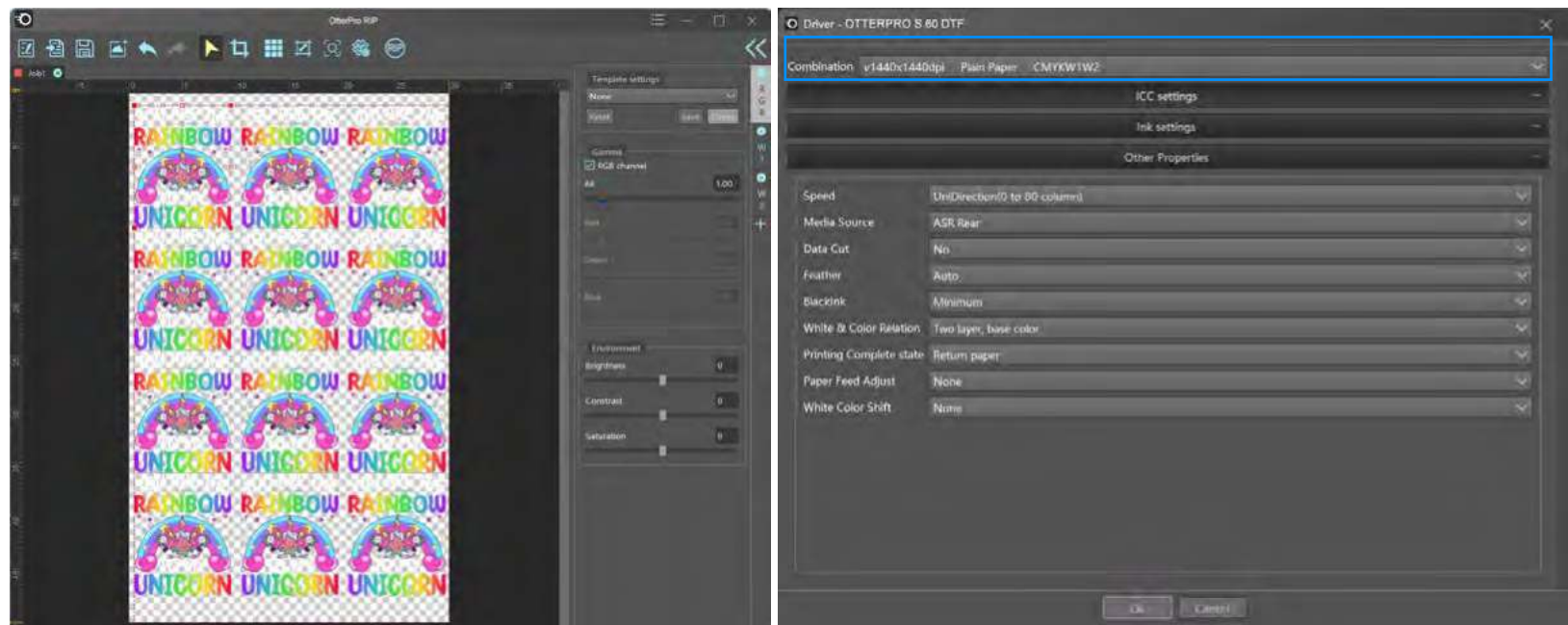

Auto Layout

Batch printing with high efficiency

Customized ICC Profiles

Streamlining your workflow for optimal productivity.



OtterPro RIP Software

This software significantly boosts the productivity of DTF printing projects! It features a simple yet powerful interface, enabling you to effortlessly master image editing and design. Moreover, it supports multi-image automatic layout and duplicate printing, greatly enhancing work efficiency. The superior color output ensures DTF printers achieve "what you see is what you get" results!

Applicable to all OtterPro Printer Systems

- ✔ Model M 30
- ✔ Model S 40
- ✔ Model S 60
- ✔ UV Model C 30

Autopress Max Heat Press



Item No.	OT-AUPB3838FLB	Temp. Range	104-401° F(40-205° C)
Power	1200W	Time Range	1-999 seconds
Voltage	230V/120V 50~60Hz	Printable Articles Max	38x38cm / 15x15in



One Touch Mode

Just touch to repeat! Batch personalization has never been simpler with a single touch.



Retracting Drawer

Effortless and elegant handle design that saves space; the retracting drawer offers you more room for easy prep work.



Intelligent Pressure

For substrates up to 2 cm thick, perfectly consistent pressure every time, with no guesswork.



Premium Heating Element

Redesigned for unmatched efficiency and even heating with 15"x 15" heating platen.



Unmatched Clarity and Convenience

Discover the ease of an expanded screen for effortless navigation, visualization, and settings adjustment. Create more with a timer that extends up to 8 minutes for larger projects.

Clamshell Heat Press

Specially designed for DTF printing! Unlike the previous horizontal version, this 40x50cm/16x20inch vertical heating platen design is more suitable for garment printing. The uniformly heating platen ensures exceptional printing results every time, making it an excellent choice for a DTF heat transfer!



Premium Heating Element Vertical Heating Platen

The Heat Press features an even heating platen board, which is essential for ensuring consistent results when heat transfers onto your substrates.

Ideal for T-shirt printing

Item No.	OT-PB3838MDLB	OT-PB4050SMDLB	OT-PB4060MDLB
Heat Platen	38x38cm / 15x15in	40x50cm / 16x20in	40x60cm / 16x24in
Power	2000W /1300W MAX±5%	2200W /1600W MAX±5%	2400W /1800W MAX±5%
Voltage	220V / 110V 50~60Hz		
Temp. Range	0-482 °F (0-250°C)		
Time Range	0-999 seconds		



Optional Configurations

- Manual**
 - ✗ Slide-Out Drawer
 - ✗ Auto-Open
- Drawer**
 - ✓ Slide-Out Drawer
 - ✗ Auto-Open
- Auto-Open**
 - ✓ Slide-Out Drawer
 - ✓ Auto-Open

Semi-Automatic Double Station Heat Press Machine

Double the efficiency of your DTF heat transfer projects with our dual-station design. Now, you can do the prep work while printing, saving both time and effort!



- High Efficiency**
 - Dual Station
 - Smooth Sliding Design
- Safety**
 - Built-in Cooling System
 - Overload Protection
 - Emergency Stop
 - Overheat Protection
 - Protective Relay
- Premium Construction**
 - Aluminium Die Casting
 - Quick Heat-Up
 - Even Heating
 - Precision Cut Forging
- Convenient**
 - Ease of Use
 - Touch-screen Design
 - Ideal for T-shirt Printing

Item No.	OT-DSPB4050LB
Heat Platen	40x50cm / 16x20in
Power	2200W /1600W MAX±5%
Voltage	220V / 110V 50~60Hz
Temp. Range	0-482 °F (0-250°C)
Time Range	0-999 seconds



Smooth Sliding Design

Premium Heating Element

Air Press Swing Dual Station Heat Press

This air-operated heat press uses air pressure to apply consistent, uniform heat and pressure to your substrates. With its swing-away and double-station designs, you can prepare your next project while one is being printed, saving you time and effort!



High Efficiency

Dual Station
Swing-away Design
Air-operated
Auto Press & Release



Safety

Built-in Cooling System
Overload Protection
Emergency Stop
Overheat Protection
Protective Relay
Dual Buttons for Safer Operation



Premium Construction

Aluminium Die Casting
Quick Heat-Up
Even Heating
Precision Cut Forging



Convenient

Ease of Use
Touch-screen Design
Ideal for T-shirt Printing

Item No.	OT-DQSPBY3838LB	Voltage	220V / 110V 50~60Hz
Heat Platen	38x38cm / 15x15in	Temp. Range	0-482 °F (0-250°C)
Power	2000W /1300W MAX±5%	Time Range	0-999 seconds



Swing-away Design

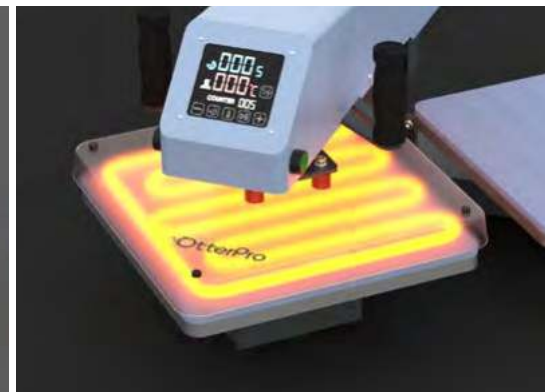

Premium Heating Element

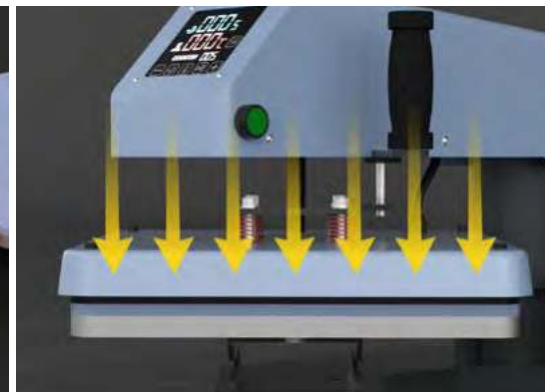

Automatic Pneumatic System

Air Press Slide Dual Station Heat Press

Maximize your heat transfer productivity and efficiency with this air-operated heat press! Slide, press, and repeat—batch personalization has never been easier!

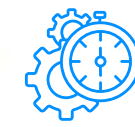

High Efficiency

Dual Station
Smooth Sliding Design
Air-operated
Auto Press & Release



Safety

Built-in Cooling System
Overload protection
Emergency Stop
Overheat Protection
Protective Relay
Dual Buttons for Safer Operation



Premium Construction

Aluminium Die Casting
Quick Heat-Up
Even Heating
Precision Cut Forging



Convenient

Ease of Use
Touch-screen Design
Ideal for T-shirt Printing

Item No.	OT-QSH4050LB	Voltage	220V / 110V 50~60Hz
Heat Platen	40x50cm / 16x20in	Temp. Range	0-482 °F (0-250°C)
Power	2200W /1600W MAX±5%	Time Range	0-999 seconds

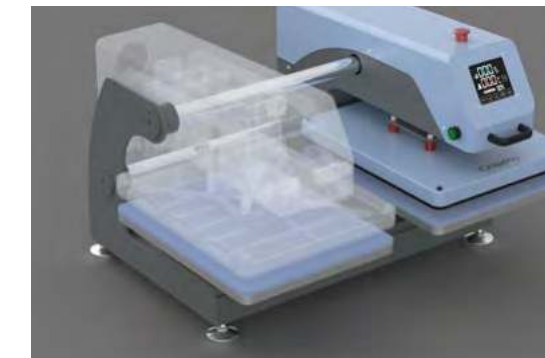

Smooth Sliding Design



Premium Heating Element

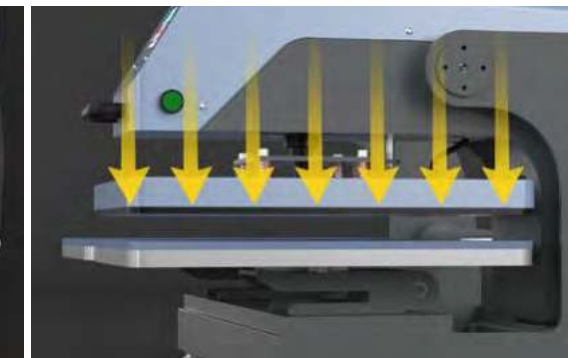

Automatic Pneumatic System

Large Format Heat Press

This industrial oversized heat press is designed for printing larger projects, meeting batch printing needs in your custom garment business. When paired with DTF printing technology, it enables not only custom logo printing on t-shirts but also full print customization on garments.



Premium Heating Element

The Heat Press features an evenly heating element, which is essential for ensuring consistent results when heat transfers onto your substrates.



Oversized Heating Platen

It has an oversized heating platen, suitable for making full printing on large creations, like towels, blankets, tablecloths, pants, banners and more.



High Efficiency

Unlike a small-format heat press, this heat press can print dozens of photo frames, ornaments, and even 4 t-shirts at the same time, significantly enhancing heat transfer efficiency.



Stable & Safe

With its anti-scald cover and air circuit breaker, it provides enhanced safety during operation.

Item No.	OT-PB6080DLB	OT-PB80100DLB
Heat Platen	60x80cm / 24x32in	80x100cm / 32x40in
Power	6000W MAX±5%	6600W MAX±5%
Voltage	380V 50Hz	
Temp. Range	0-482 °F (0-250°C)	
Time Range	0-999 seconds	

Model S 40 DTF Printer-Spare Parts



OTTER-I1600PT
Printhead



OTTER-40ZB
Printer Mainboard



OTTER-40PTZB
Printhead Mainboard



OTTER-40CSD
DTF Drive Belt



OTTER-40XMD
Cap Top



OTTER-40MG
Ink Tube



OTTER-40GST
Encoder Strip

Model S 40/60 DTF Printer-Universal Spare Parts



OTTER-40WKZB
Temp. Control Mainboard



OTTER-40FLQ
White Ink Circulation Splitter



OTTER-40GLQ
Ink Filter



OTTER-40GMP
Wiper Blade



OTTER-40MN
Ink Damper

Model S 60 DTF Printer-Spare Parts



OTTER-I3200A1PT
Printhead



OTTER-60ZB
Printer Mainboard



OTTER-60GST
Encoder Strip



OTTER-60PTZB
Printhead Mainboard



OTTER-60CSD
DTF Drive Belt



OTTER-60XMD
Cap Top



OTTER-60MG
Ink Tube

DTF Powder



- Strong Adhesion
- Good Wash Durability
- High Color Fastness
- Eco-friendly
- Cost-effective
- No Color Fading

OT-DTFRRF500
500g
OT-DTFRRF1000
1000g

OT-DTFPDT600
600g
OT-DTFPDT1000
1000g

OtterPro DTF ink

Sustainable Inks

OtterPro DTF pigment ink is eco-friendly and water-based ink, made with non-toxic ingredients that are safe to use and soft to the touch, perfectly in line with our commitment to sustainability.

- Eco-friendly
- Easy to Transfer
- Deep Whites for Vibrant Results



500ml DTF ink
OT-DTINK500C (Cyan)
OT-DTINK500M (Magenta)
OT-DTINK500Y (Yellow)
OT-DTINK500K (Black)
OT-DTINK500W (White)



1000ml DTF ink
OT-DTINK1000C (Cyan)
OT-DTINK1000M (Magenta)
OT-DTINK1000Y (Yellow)
OT-DTINK1000K (Black)
OT-DTINK1000W (White)

OtterPro Ultra DTF Ink

OtterPro Ultra DTF ink is an eco-friendly, water-based ink made with non-toxic ingredients and a special formula. When used with OtterPro Precipitation-Free DTF White Ink, it ensures clog-free printheads and provides smooth, consistent ink flow without settling.

- Clog-Free Printheads
- Easy to Transfer
- Eco-friendly
- Deep Whites for Vibrant Results



500ml Ultra DTF Ink
 High Density Anti-clog Ink
OT-DTINKS500C (Cyan)
OT-DTINKS500M (Magenta)
OT-DTINKS500Y (Yellow)
OT-DTINKS500K (Black)
OT-DTINKS500W (White)











1000ml Ultra DTF Ink
 High Density Anti-clog Ink
OT-DTINKS1000C (Cyan)
OT-DTINKS1000M (Magenta)
OT-DTINKS1000Y (Yellow)
OT-DTINKS1000K (Black)
OT-DTINKS1000W (White)

Excellent Printing Results

Restore images with high definition, delivering true-to-life and vivid color output. Our advanced technology ensures that the images retain their clarity while remaining resistant to deformation and fading.



		
Vibrant Color	High Definition	Strong Adhesion
		
Stretchable	Breathable	Soft Texture
		
Wash-Resistant	Long-Lasting	

Perfect for any dark or light colored fabric



100% Cotton

- Polyester
- Nylon
- Canvas
- 50/50 Blends
- Leather
- And more!

DTF Film

Available Sizes for All DTF Film



21 cm x 30 cm
8.3 in x 11.8 in

30 cm x 42 cm
11.8 in x 16.5 in



30 cm x 10 m
11.8 in x 32.8 ft

30 cm x 100 m
11.8 in x 328 ft

42 cm x 100 m
16.5 in x 328 ft

60 cm x 100 m
23.6 in x 328 ft

Hot & Cold Peel DTF Film

DOUBLE-SIDED MATTE

This double-side matte finish DTF printing film offers flexibility-peel it after heat transfer or wait until it cools. Its strong adhesion efficiently absorbs DTF ink, guaranteeing high-definition and vibrant color output.

Size	DOUBLE-SIDED
A3	OT-DTFFILMA3
A4	OT-DTFFILMA4
0.3m*10m	OT-DTFFILM3010
0.3m*100m	OT-DTFFILM30100
0.42m*100m	OT-DTFFILM42100
0.6m*100m	OT-DTFFILM60100





Glow in Dark

COLD PEEL

Add a unique and eye-catching element to your fabric.



Gradient Series

COLD PEEL

Elevate your style with a metallic texture.



GOLD



GRADIENT



GLITTER SILVER



GLITTER GOLD



GLITTER RAINBOW



HOLOGRAPHIC

Glitter Series

COLD PEEL

Let your design shine in the crowd.

Size	GOLD	GRADIENT	GLITTER SILVER	GLITTER GOLD	GLITTER RAINBOW	HOLOGRAPHIC	GLOW IN DARK
A3	OT-DTFFILMGDA3	OT-DTFFILMJBA3	OT-DTFFILMZSA3	OT-DTFFILMSGA3	OT-DTFFILMXCA3	OT-DTFFILMHCA3	OT-DTFFILMYGA3
A4	OT-DTFFILMGDA4	OT-DTFFILMJBA4	OT-DTFFILMZSA4	OT-DTFFILMSGA4	OT-DTFFILMXCA4	OT-DTFFILMHCA4	OT-DTFFILMYGA4
0.3m*10m	OT-DTFFILMGD3010	OT-DTFFILMJB3010	OT-DTFFILMZS3010	OT-DTFFILMSG3010	OT-DTFFILMXC3010	OT-DTFFILMHC3010	OT-DTFFILMYG3010
0.3m*100m	OT-DTFFILMGD30100	OT-DTFFILMJB30100	OT-DTFFILMZS30100	OT-DTFFILMSG30100	OT-DTFFILMXC30100	OT-DTFFILMHC30100	OT-DTFFILMYG30100
0.42m*100m	OT-DTFFILMGD42100	OT-DTFFILMJB42100	OT-DTFFILMZS42100	OT-DTFFILMSG42100	OT-DTFFILMXC42100	OT-DTFFILMHC42100	OT-DTFFILMYG42100
0.6m*100m	OT-DTFFILMGD60100	OT-DTFFILMJB60100	OT-DTFFILMZS60100	OT-DTFFILMSG60100	OT-DTFFILMXC60100	OT-DTFFILMHC60100	OT-DTFFILMYG60100

OtterPro UV DTF Ink

OtterPro UV DTF ink is a specially formulated oil-based ink that ensures smooth, consistent flow without clogging the printhead. Its high color density delivers rich, vibrant colors for your prints.



500ml UV DTF ink

- C30-INK500C (Cyan)
- C30-INK500M (Magenta)
- C30-INK500Y (Yellow)
- C30-INK500K (Black)
- C30-INK500W (White)
- C30-INK500V (Vanish)

OtterPro UV DTF Transfer AB Film



C3032100CA
UV DTF A Film
Size: 0.32*100M



C3032100CB
UV DTF B Film
Size: 0.32*100M



Model C 30 UV DTF-Spare Parts



C30-PT3200
Printhead
Epson I3200U1HD



C30-CZB
Control Board



C30-PTZB
Printhead Main Board



C30-XMD
Cap Top



C30-GMP
Wiper Blade



C30-MG
Ink Tube



C30-MN
Damper

VISIT US

for new releases and tutorials on our website.

WWW.OTTERDTF.COM

FOLLOW US FOR THE LATEST UPDATES!

@otterdtf

